

Front view

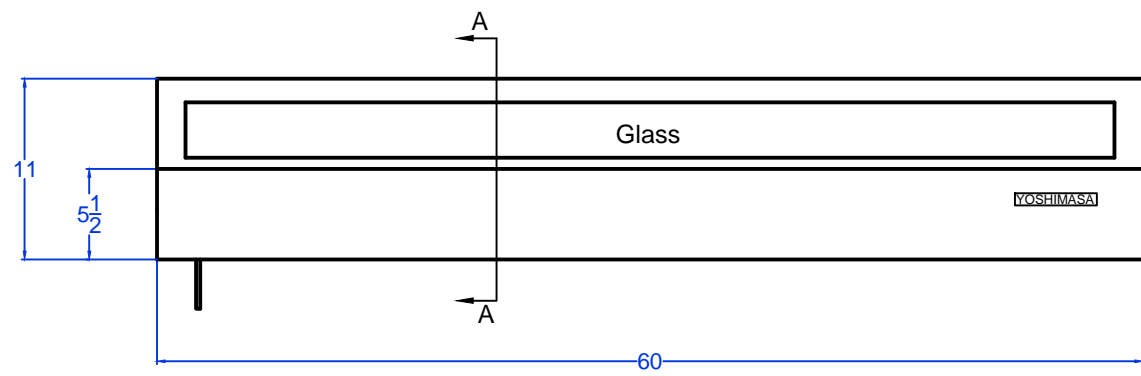

A-A Section view

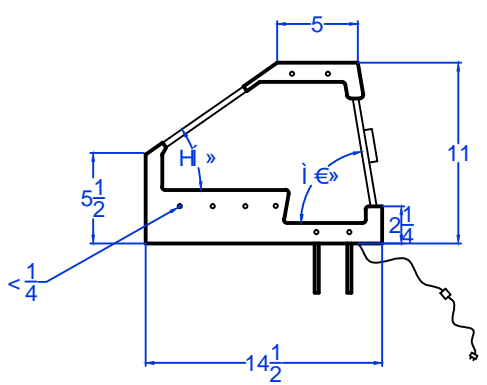

Rear view

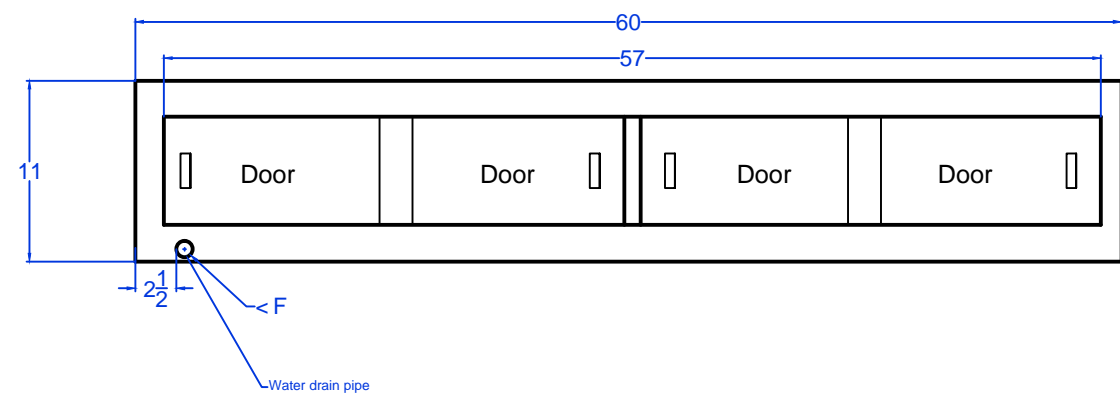

Bottom view

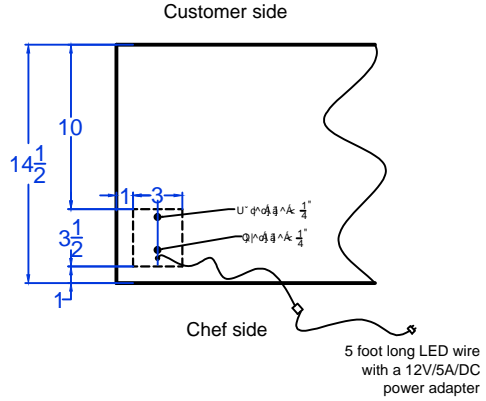

OBATA- 5M

Unit	Inch	Scale	1:1
------	------	-------	-----