

Front view

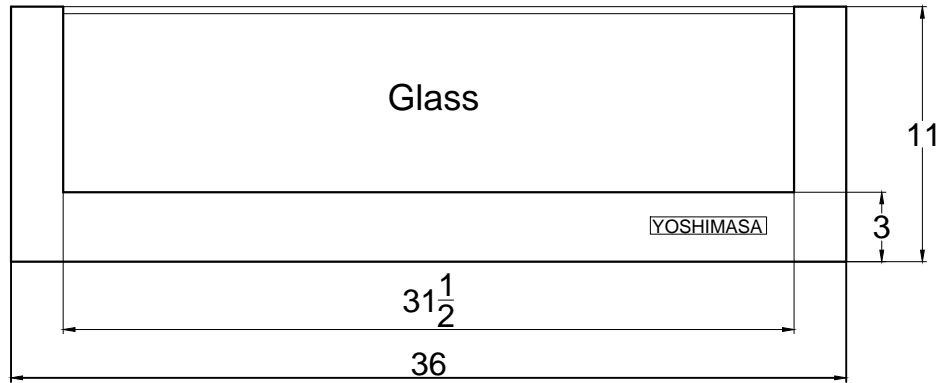

Right side view

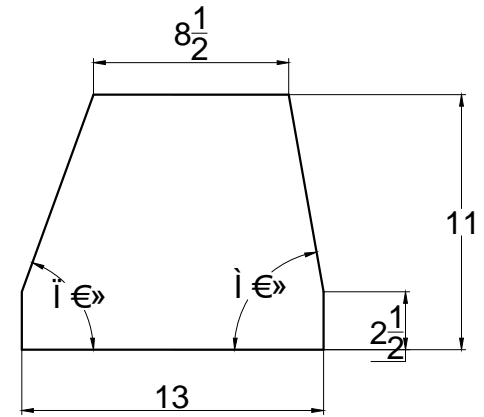

Rear view

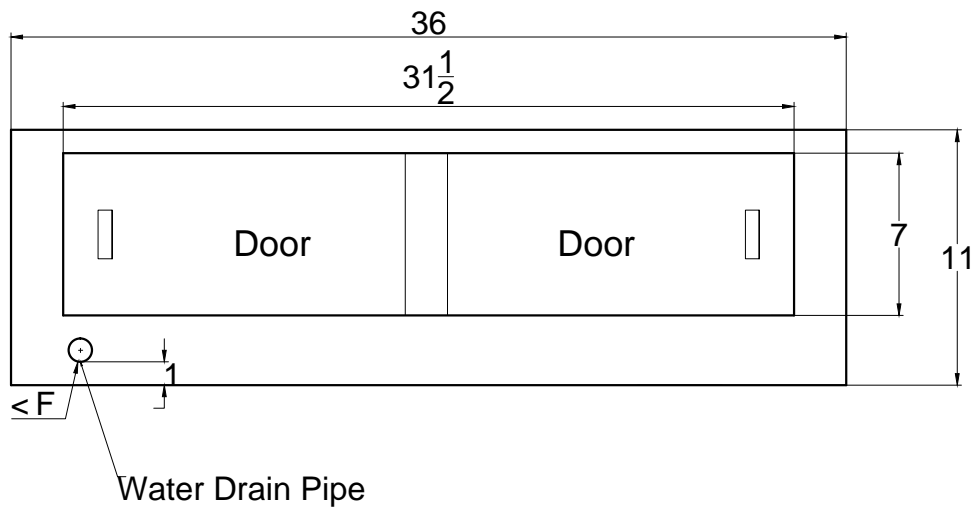

NUDO-OYSTER-3M

Unit	Inch	Scale	1:1
------	------	-------	-----